

POWERPLAY PRO HA4600

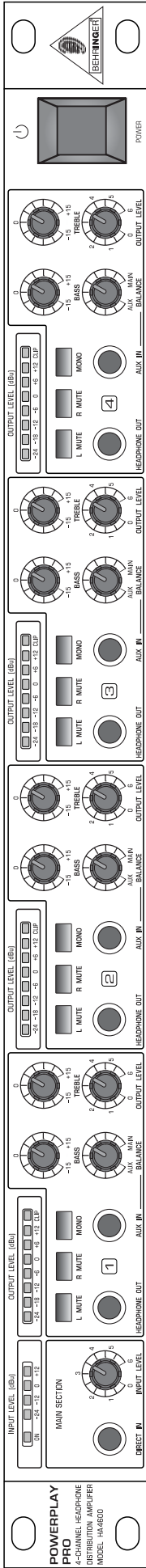

User's Manual

Version 1.1 January 2004

ENGLISH

www.behringer.com



POWERPLAY PRO HA4600

IMPORTANT SAFETY INSTRUCTIONS



CAUTION: To reduce the risk of electric shock, do not remove the top cover (or the rear section). No user serviceable parts inside; refer servicing to qualified personnel.

WARNING: To reduce the risk of fire or electric shock, do not expose this appliance to rain and moisture.



This symbol, wherever it appears, alerts you to the presence of uninsulated dangerous voltage inside the enclosure—voltage that may be sufficient to constitute a risk of shock.



This symbol, wherever it appears, alerts you to important operating and maintenance instructions in the accompanying literature. Please read the manual.

DETAILED SAFETY INSTRUCTIONS:

- 1) Read these instructions.
 - 2) Keep these instructions.
 - 3) Heed all warnings.
 - 4) Follow all instructions.
 - 5) Do not use this device near water.
 - 6) Clean only with a dry cloth.
 - 7) Do not block any ventilation openings. Install in accordance with the manufacturer's instructions.
 - 8) Do not install near any heat sources such as radiators, heat registers, stoves, or other apparatus (including amplifiers) that produce heat.
 - 9) Do not defeat the safety purpose of the polarized or grounding-type plug. A polarized plug has two blades with one wider than the other. A grounding type plug has two blades and a third grounding prong. The wide blade or the third prong are provided for your safety. If the provided plug does not fit into your outlet, consult an electrician for replacement of the obsolete outlet.
 - 10) Protect the power cord from being walked on or pinched particularly at plugs, extension cords, and the point at which they exit the unit.
 - 11) Only use attachments/accessories specified by the manufacturer.
 - 12) Use only with the cart, stand, tripod, bracket, or table specified by the manufacturer, or sold with the device. When a cart is used, use caution when moving the cart/device combination to avoid injury from stumbling over it.
- 
- 13) Unplug this device during lightning storms or when not used for long periods of time.
 - 14) Refer all servicing to qualified service personnel. Servicing is required when the unit has been damaged in any way, such as power supply cord or plug is damaged, liquid has been spilled or objects have fallen into the device, the unit has been exposed to rain or moisture, does not operate normally, or has been dropped.

FOREWORD

Dear Customer,

Welcome to the team of POWERPLAY PRO users and many thanks for the confidence that you have shown in us by purchasing the HA4600. It is one of my most pleasant tasks to write this letter to you, because after many months of hard work our engineers have achieved a very ambitious goal: the presentation of an outstanding piece of equipment, which thanks to its flexibility can be used both in studios and by in live sound applications. The task of developing our new POWERPLAY PRO has meant a great deal of responsibility. As we continued to develop it further, you—the discerning end-user and musician—were always at the forefront of our thoughts. Meeting this responsibility also involved us in considerable effort and late-night working, but it was fun, too. This type of development always brings together a large number of people, and it is a great feeling when all those involved can be proud of the results of their work.

Our philosophy is that you should also share in this satisfaction. You are the most important member of our team. With your highly competent encouragement and suggestions for new products, you have greatly contributed to shaping our company and to making it successful. In return we guarantee you an uncompromising level of quality (manufactured under ISO9000 certified management system), excellent technical and audio characteristics and an extremely favorable price. All this makes it possible for you to develop your fullest potential, without being hampered by budget constraints.

We are often asked how we manage to manufacture equipment of this quality at such unbelievably low prices. The answer is very simple: You make it possible! Many satisfied customers means large sales volumes. Large sales volumes means we can get better purchase prices for components etc. Isn't it only fair for us to pass this benefit back to you? After all, we know that your success is our success, too!

I would like to thank everyone who has helped make the POWERPLAY PRO possible. All have made their own personal contribution, beginning with the developers, through the many employees of our company and up to you, the user of BEHRINGER products.

My friends, it's been worth the trouble!

Thank you very much,

A handwritten signature in black ink, appearing to read 'U. Behringer', with a long horizontal flourish extending to the right.

Uli Behringer

POWERPLAY PRO HA4600

POWERPLAY PRO

Professional multi-purpose headphone amplifier system for stage and studio applications

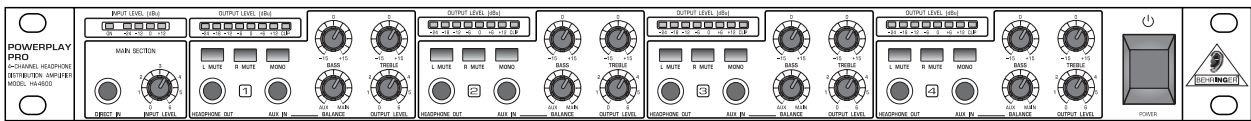

- ▲ Four totally independent high-power stereo amplifiers in one rack space
- ▲ Four independent input/aux sections provide up to four stereo mixes
- ▲ Stereo aux input for each channel allows you to mix in any additional instrument or sound source
- ▲ Ultra-musical 2-band EQ per channel for effective sound adaptation
- ▲ Highest sonic quality even at maximum volume
- ▲ Output level control per channel
- ▲ Mono / stereo switch per channel for more flexibility
- ▲ Left & right mute switches per channel allow two different mixes in mono mode
- ▲ One front and two rear 1/4" TRS outputs per channel
- ▲ Accurate 8-digit LED output meter per channel
- ▲ Front panel direct input connector for easy connection of any source
- ▲ Paralleled main outputs allow cascading of several headphone amplifiers
- ▲ Servo-balanced, gold-plated XLR and 1/4" TRS inputs and outputs
- ▲ Ultra low-noise 4580 operational amplifiers for outstanding audio performance
- ▲ High-quality detented ALPS potentiometers and illuminated switches
- ▲ High-quality components and exceptionally rugged construction for long life and durability
- ▲ Shielded toroidal power transformer for minimal noise interference
- ▲ Designed in Germany. Manufactured under the ISO9000 certified management system

TABLE OF CONTENTS

1. INTRODUCTION	5
1.1 Before you begin	5
2. CONTROL ELEMENTS	6
2.1 The front panel control elements	6
2.2 The rear panel controls elements	7
3. APPLICATIONS	8
3.1 Using the MAIN Inputs	8
3.2 Using the AUX IN Inputs	8
3.3 Using the DIRECT IN input	9
3.4 Using the MONO function	9
3.5 Using the MUTE function	9
3.6 Connecting several headphones	10
4. AUDIO CONNECTIONS	10
5. SPECIFICATIONS	11
6. WARRANTY	12

1. INTRODUCTION

In purchasing the BEHRINGER POWERPLAY PRO HA4600 you have acquired a headphone amplifier of the high end-class. The equipment was developed for the most demanding uses: professional recording, radio and TV studios, CD and digital production equipment etc. Its extensive capabilities make the POWERPLAY PRO universally applicable. It was developed for use both as a reference unit, to assess the quality of a final mix, and as a distribution amplifier for the comfortable addition of playbacks in studio use.

The POWERPLAY PRO has a range of switching possibilities and a sound performance, which are found in few headphone amplifiers. Besides its extremely powerful amplifiers the HA4600 also has an ingenious signal-source distribution system.

Improving on the well-known POWERPLAY PRO unit was a big challenge. We are proud that we have been able to develop further the innovations we introduced in the preceding models and to have developed an even more high-value headphone amplifier, which can meet professional expectations in every type of application. The HA4600 includes for example bass and high-EQ in each channel, making possible an even more individualized audio setup. An 8-segment LED display gives you exact information on the performance of each channel and makes it possible to control the level precisely, at any time.

 **This manual first describes the terminology used, so that you can fully understand the POWERPLAY PRO and its functions. Please read the manual carefully and keep it for future reference.**

1.1 Before you begin

The POWERPLAY PRO was carefully packed in the factory, in order to ensure safe transport. Nevertheless, should the box show signs of damage please check the equipment itself immediately for any signs of external damage.

Please also take the time to complete and return the warranty card within 14 days of the date of purchase, otherwise you will lose the right to the extended warranty. Or simply use our online registration under www.behringer.com.

POWERPLAY PRO HA4600

 If the unit is damaged, please do not return it to us, but notify your dealer and the shipping company immediately, otherwise claims for damage or replacement may not be granted. Shipping claims must be made by the consignee.

Be sure that there is enough space around the unit for cooling and please do not place the POWERPLAY PRO on high-temperature devices such as power amplifiers, etc. to avoid overheating.

 Before connecting the POWERPLAY PRO to the mains, please carefully check that your equipment is set to the correct supply voltage!

The fuse holder on the female mains connector has 3 triangular markings. Two of these triangles are opposite each other. The HA4600 is set to the operating voltage shown next to these markings. It can be set to another voltage by turning the fuse holder through 180°. **CAUTION: this does not apply to export models, which were designed e.g. only for a mains voltage of 120 V!**

Connection to the mains is made by means of a mains cable with an IEC receptacle which complies with the appropriate safety regulations.

 Please note that all units must be grounded properly. For your own safety, you should never remove any ground connectors from electrical devices or power cords or render them inoperative.

WARNING!

 It should be pointed out, that extreme output volumes may damage your ears and/or your headphones. Turn down all LEVEL controls before you switch on the unit. Always pay attention to an appropriate volume.

2. CONTROL ELEMENTS

The BEHRINGER POWERPLAY PRO has four identical channels. Each channel has three illuminated push-button switches, four rotary controls, two jacks and eight LEDs. The common main section has one control, one jack and five LEDs.

2.1 The front panel control elements

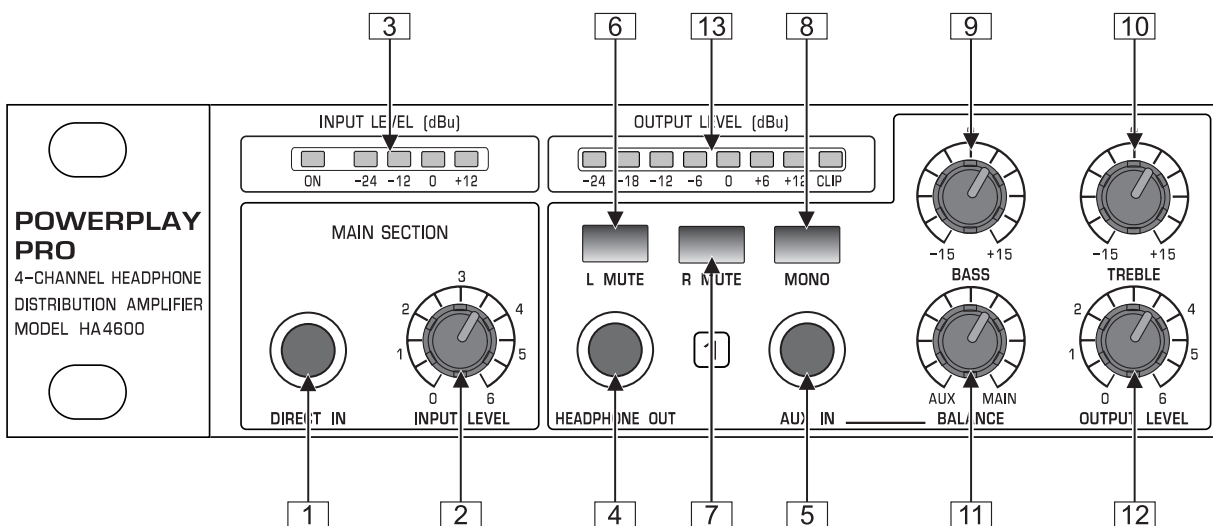



Fig. 2.1: The POWERPLAY PRO front panel

-  The *DIRECT IN* socket is used to apply external signal sources. Use of this input automatically cuts off the MAIN signal applied on the rear panel.
-  The *INPUT LEVEL* control adjusts the sound level of the input signal, which is fed in via the rear panel MAIN INPUT socket.

POWERPLAY PRO HA4600

- 3 The 4-digit *INPUT LEVEL* display shows the input level over a range from -24 to +12 dBu. The *ON* LED lights up when you switch on the HA4600.
- 4 The *HEADPHONE OUT* socket is connected in parallel with the output sockets on the rear panel and provides an additional means of listening to the individual channels. This function is particularly useful when the equipment has been permanently installed in a rack.
- 5 A further input signal can be mixed in to the *MAIN* or the *DIRECT IN*-Signal via the *AUX IN*-input.
- 6 The *L MUTE* switch mutes the left input signal.
- 7 The *R MUTE* switch mutes the right input signal.
- 8 The *MONO* switch can be used to switch each of the amplifiers from stereo to mono operation.
- 9 The *BASS* control can be used to increase or decrease the lower frequencies (+/-15 dB).
- 10 The *TREBLE* control can be used to increase or decrease the higher frequencies (+/-15 dB).
- 11 The *BALANCE* control sets the ratio level between the *MAIN* or *DIRECT IN* signal and the input signal, which was applied to the *AUX* input.
- 12 The *OUTPUT LEVEL* control is used to set the sound level of each individual amplifier. At the same time it also controls the left and right channels.
- 13 The 8-digit *OUTPUT LEVEL* display monitors the output level of each individual channel over the range from -24 to +12 dBu. If the *Clip*-LED lights up, please reduce the gain of the current channel, otherwise distortion may result.

2.2 The rear panel control elements

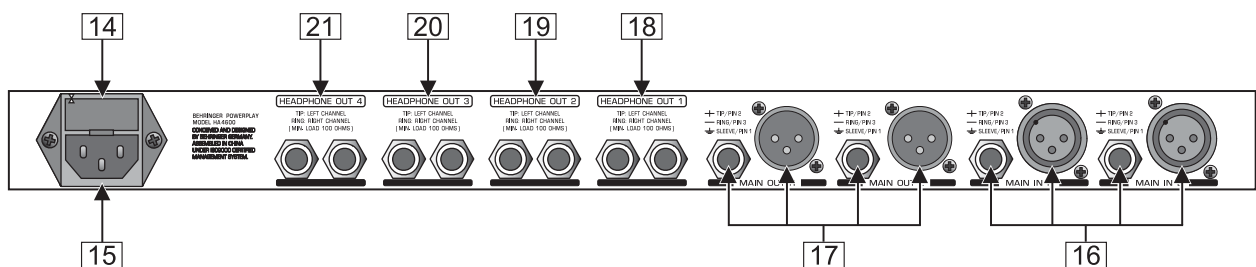

Fig. 2.2: The *POWERPLAY PRO HA4600* rear panel

- 14 *FUSE HOLDER/VOLTAGE SELECTOR*. Before connecting the equipment to the mains supply, please check that the voltage displayed on the unit conforms with your mains voltage supply. When replacing the fuse, make sure you use another one of the same type.
- 15 The mains connection is made via a standard *IEC RECEPTACLE*. A suitable connecting cable is supplied with the equipment.
- 16 *MAIN IN*. These are the *POWERPLAY PRO* audio inputs. They are available both as balanced 1/4" TRS and XLR connectors.
- 17 *MAIN OUT*. These are the *POWERPLAY PRO* audio outputs. The matching 1/4" TRS and XLR connectors are wired in parallel.
- 18 *HEADPHONE OUT 1*. These are the headphone outputs of channel 1.
- 19 *HEADPHONE OUT 2*. These are the headphone outputs of channel 2.
- 20 *HEADPHONE OUT 3*. These are the headphone outputs of channel 3.
- 21 *HEADPHONE OUT 4*. These are the headphone outputs of channel 4.

POWERPLAY PRO HA4600

3. APPLICATIONS

3.1 Using the MAIN inputs

Connect a program source to the rear panel MAIN inputs and connect the headphone cable with one of the POWERPLAY PRO outputs. Turn the INPUT LEVEL and the BALANCE controls to their central positions. The INPUT LEVEL control is used to increase or decrease together the volume of all the headphones which are being controlled via the MAIN inputs. The individual OUTPUT LEVEL controls are only used to adjust the desired channel volume.

3.2 Using the AUX IN inputs

The AUX IN inputs are basically used to mix in an additional input signal with the master signal, while the corresponding BALANCE control adjusts the volume ratio between the two signals. The Aux function replaces the monitor mixer which was necessary up to now, and so allows for a type of use which occurs frequently in practice.

Suppose e.g. that a singer has to add a vocal track to an existing playback. Up till now it was usual for the singer to listen to the playback by pressing a headphone pad against one ear, while using the other ear to control his/her own voice. With the POWERPLAY PRO this application becomes much simpler and much more comfortable. The playback signal is played in via the MAIN IN inputs and the pre-amplified vocal signal added via the AUX connector. The associated BALANCE control is adjusted so that the singer hears a perfect sound volume mix of both the playback and the vocals, with the OUTPUT LEVEL control determining the overall volume level.

The four independent channels permit the separate recording and mixing for four musicians. Should this not be enough, you can interface and link as many POWERPLAY PRO machines as desired using the MAIN OUT outputs.

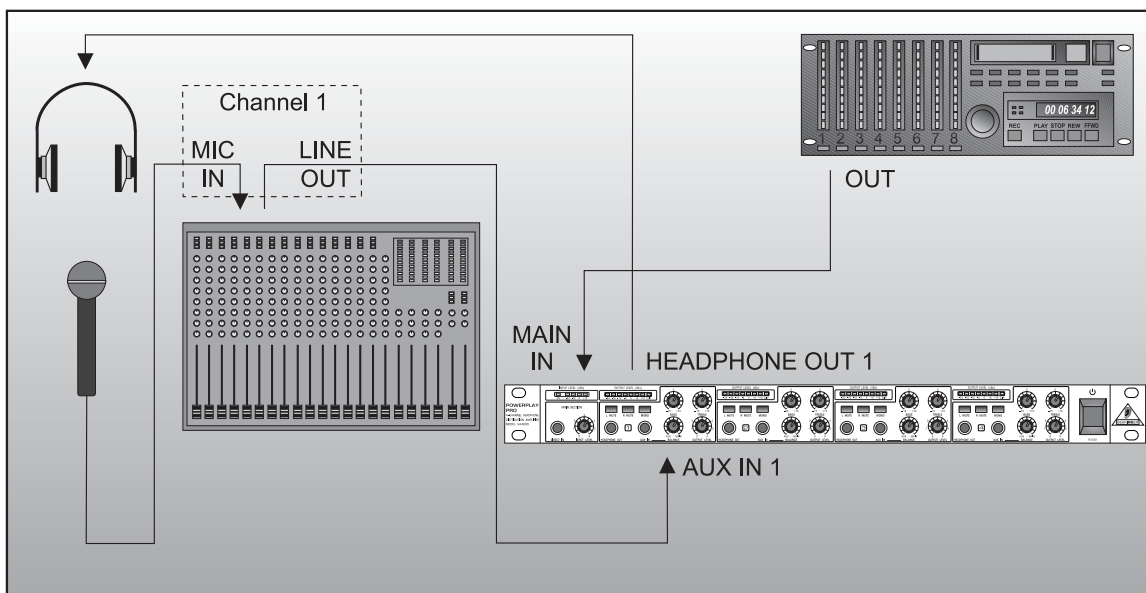

Fig. 3.1: Example of a playback application in a studio

In addition to the joint control of all channels via the MAIN input, each of the four amplifiers can also be used completely independently. The AUX IN inputs are used here, together with the BALANCE controls. When the BALANCE control is set fully counterclockwise ("AUX" position) the MAIN signal is suppressed and only the input signals set up via the AUX IN input are fed through to the appropriate power amplifier. By using each amplifier separately you can now play in up to four independent stereo programs. This means that you can play in different, individual mixes for four musicians at the same time. As with a stage monitoring system you then have the advantage of being able to play a specific configuration of instruments for each musician, giving him a musically inspiring mix; or you can (e.g.) in a conference system set up different signal paths for the interpreters. Create sub-groups, or set up premixes using the effects and monitor facilities of your mixing console. To do this, turn the BALANCE control fully counterclockwise and connect the AUX inputs of the BEHRINGER

POWERPLAY PRO HA4600

POWERPLAY PRO with the appropriate monitor-, subgroup or single outputs from the mixing console. Please note that the AUX inputs are set up for stereo. To play in a stereo signal you will need a stereo jack. If you use a mono jack it is advisable to activate the MONO switch, so as to get a signal distribution over both halves of the headphone.

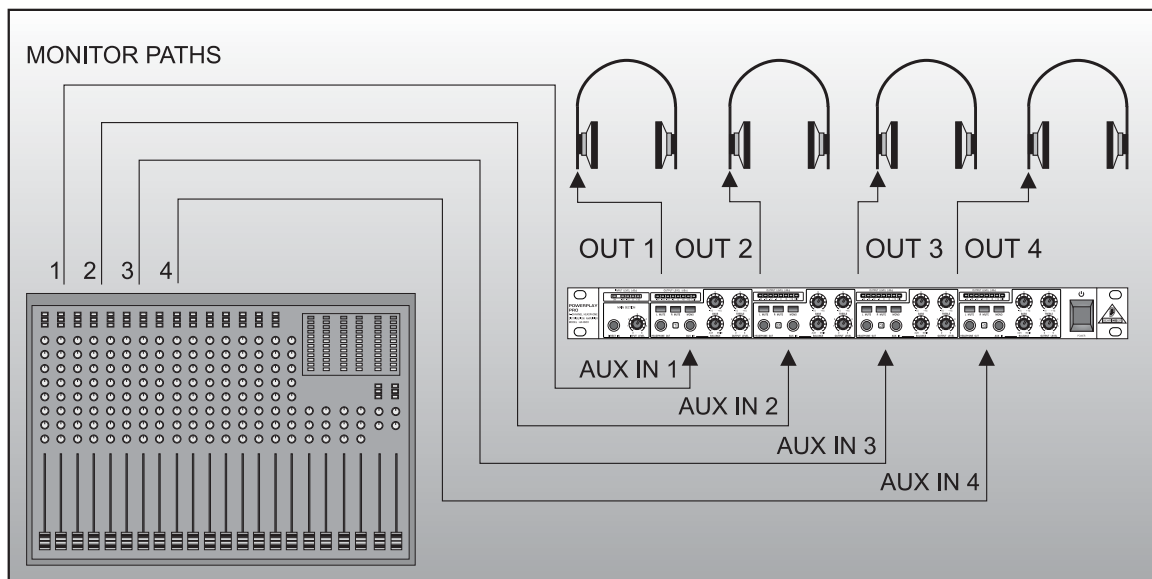

Fig. 3.2: Example of a monitor recording in stage use

3.3 Using the DIRECT IN input

The DIRECT IN socket is situated on the left side of the front panel. It is often necessary e.g. to replay a piece of music to the musicians in the studio via a DAT recorder. This can be done simply and easily using the DIRECT IN socket. Use of this input automatically blocks the signal set up over the MAIN IN socket.

3.4 Using the MONO function

For some monitor applications, especially in live operation, a stereo program can often sound irritating. This negative effect becomes particularly clear if the two channels show a large channel separation, i.e. they have different information content, linked with significantly different impressions of sound volume. The MONO switch permits mono operation, that is, the linked operation of the left and right channels without having to use a “Y” adaptor or a special cable.

3.5 Using the MUTE function

If the MONO switch is in the depressed position, the unit works in mono operation. Pressing one of the two MUTE switches mutes the corresponding input signal (left or right input) and the non-muted signal can then be heard over BOTH (left and right) headphone outputs. This routing option means that you can set up two different programs via the left and right inputs and make just the one or the other audible as desired.

The Mute function is particularly useful if playback is to be combined with the simultaneous recording of a vocal track. Whereas before it was necessary for a singer to hold one headphone pad away from his/her ear during a music recording in order to hear his own voice better, with the HA4600 the playback can now be switched to stereo mode and the unused channel switched to mute. The previous normal—and uncomfortable—practice of moving one headphone pad away from the ear is now a thing of the past.

3.6 Connecting several headphones

All four stereo amplifiers have three headphone output sockets on both the front and rear panels. This means that several headphones can be connected via each amplifier at the same time, provided that the minimum connection impedance of the amplifier does not drop below 100 Ohm. Since the amplifiers are resistant to temporary short circuits, no damage will occur if the level drops below this impedance, but it can lead to a loss of quality in the form of distortion and reduced performance.

POWERPLAY PRO HA4600

4. AUDIO CONNECTIONS

As a standard, the BEHRINGER POWERPLAY PRO is equipped with electronically servo-balanced inputs and outputs. The circuit design features automatic hum suppression for balanced signals and so ensures trouble-free operation, even at the highest operating levels. Externally induced mains hum, etc. can therefore be effectively suppressed. The automatic servo-function recognizes the presence of unbalanced connectors and adjusts the nominal level internally to avoid level differences between the input and output signals (6-dB correction).

 **Please ensure that only qualified persons install and operate the POWERPLAY PRO. During installation and operation the user must have sufficient electrical contact to earth. Electrostatic charges might affect the operation of the unit.**

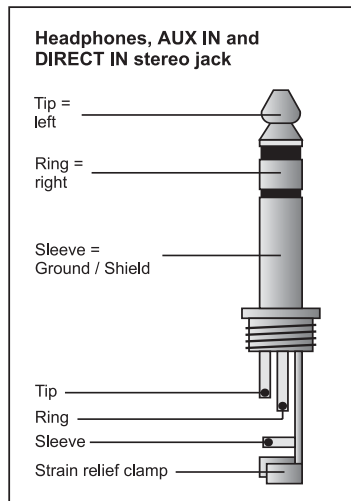

Fig. 4.1: Connector for the headphones, AUX IN and DIRECT IN

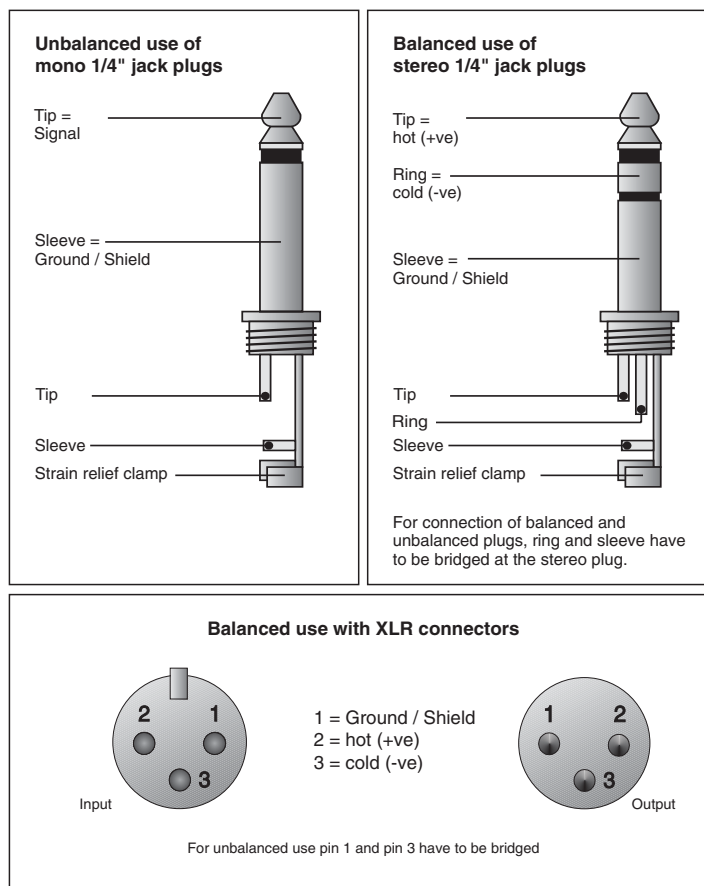

Fig. 4.2: Different plug types

5. SPECIFICATIONS

AUDIO INPUTS

MAIN Input

Connectors	XLR- and 1/4" TRS
Type	HF-filtered, servo-balanced input
Impedance	40 k Ω balanced, 20 k Ω unbalanced
Max. input level	+21 dBu balanced and unbalanced
CMRR	typically 40 dB, >55 dB @ 1 kHz

AUX IN and DIRECT IN Input

Connectors	1/4" TRS (tip = left, ring = right, sleeve = ground)
Type	unbalanced
Impedance	>15 k Ω unbalanced
Max. input level	+21 dBu unbalanced
CMRR	typically 40 dB, >50 dB @ 1 kHz

AUDIO OUTPUTS

Connectors	XLR- and 1/4" TRS
Type	balanced / unbalanced
Impedance	depends on the input impedance
Max. output level	+21 dBu balanced and unbalanced

SYSTEM SPECIFICATIONS

Frequency response	10 Hz to 100 kHz, +/-3 dB
Noise	>99 dBu, unweighted, 22 Hz to 22 kHz (>95 dB @ +4 dBu)
Distortion (THD)	0.005 % typ. @ +4 dBu, 1 kHz, Gain 1

POWER AMPLIFIER

Max. output power	+26 dBm
Min. output impedance	100 Ω

FUNCTION CONTROLS

Input level	variable
Balance per channel	Mix between Aux and Main signals
Output level per channel	variable

FUNCTION SWITCHES

Left mute	mutes the left signal of the respective channel
Right mute	mutes the right signal of the respective channel
Mono	switches this channel to mono

DISPLAYS

Input level	4-digit LED-display: -24/-12/0/+12 dBu
Output level	8-digit LED-display: -24/-18/-12/-6/0/+6/+12 dBu/CLIP

POWER SUPPLY

Mains voltage	USA/Canada	120 V~, 60 Hz
	U.K./Australia	240 V~, 50 Hz
	Europe	230 V~, 50 Hz
	general export model	120 / 230 V~, 50 - 60 Hz
Power consumption	40 W	
Fuses	100 - 120 V~:	T 630 mA H
	200 - 240 V~:	T 315 mA H
Mains connection	standard IEC receptacle	

DIMENSIONS AND WEIGHT

Dimensions	approx. 1 3/4" (44.5 mm) x 19" (482.6 mm) x 8 1/2" (217 mm)
Weight	approx. 6 lbs. (2.7 kg)
Shipping weight	approx. 7 3/4 lbs. (3.5 kg)

BEHRINGER is constantly striving to maintain the highest professional standards. As a result of these efforts, modifications may be made from time to time to existing products without prior notice. Specifications and appearance may differ from those listed or illustrated.

6. WARRANTY

§ 1 WARRANTY CARD/ONLINE REGISTRATION

To be protected by the extended warranty, the buyer must complete and return the enclosed warranty card within 14 days of the date of purchase to BEHRINGER Spezielle Studiotechnik GmbH, in accordance with the conditions stipulated in § 3. Failure to return the card in due time (date as per postmark) will void any extended warranty claims. Based on the conditions herein, the buyer may also choose to use the online registration option via the Internet (www.behringer.com or www.behringer.de).

§ 2 WARRANTY

1. BEHRINGER (BEHRINGER Spezielle Studiotechnik GmbH including all BEHRINGER subsidiaries listed on the enclosed page, except BEHRINGER Japan) warrants the mechanical and electronic components of this product to be free of defects in material and workmanship for a period of one (1) year* from the original date of purchase, in accordance with the warranty regulations described below. If the product shows any defects within the specified warranty period that are not excluded from this warranty as described under § 4, BEHRINGER shall, at its discretion, either replace or repair the product using suitable new or reconditioned parts. In the case that other parts are used which constitute an improvement, BEHRINGER may, at its discretion, charge the customer for the additional cost of these parts.

2. If the warranty claim proves to be justified, the product will be returned to the user freight prepaid.

3. Warranty claims other than those indicated above are expressly excluded.

§ 3 RETURN AUTHORIZATION NUMBER

1. To obtain warranty service, the buyer (or his authorized dealer) must call BEHRINGER (see enclosed list) during normal business hours **BEFORE** returning the product. All inquiries must be accompanied by a description of the problem. BEHRINGER will then issue a return authorization number.

2. Subsequently, the product must be returned in its original shipping carton, together with the return authorization number to the address indicated by BEHRINGER.

3. Shipments without freight prepaid will not be accepted.

§ 4 WARRANTY REGULATIONS

1. Warranty services will be furnished only if the product is accompanied by a copy of the original retail dealer's invoice. Any product deemed eligible for repair or replacement under the terms of this warranty will be repaired or replaced.

2. If the product needs to be modified or adapted in order to comply with applicable technical or safety standards on a national or local level, in any country which is not the country for which the product was originally developed and manufactured, this modification/adaptation shall not be considered a defect in materials or workmanship. The warranty does not cover any such modification/adaptation, irrespective of whether it was carried out properly or not. Under the terms of this warranty, BEHRINGER shall not be held responsible for any cost resulting from such a modification/adaptation.

3. Free inspections and maintenance/repair work are expressly excluded from this warranty, in particular, if caused by improper handling of the product by the user. This also applies to defects caused by normal wear and tear, in particular, of faders, crossfaders, potentiometers, keys/buttons, tubes and similar parts.

4. Damages/defects caused by the following conditions are not covered by this warranty:

▲ improper handling, neglect or failure to operate the unit in compliance with the instructions given in BEHRINGER user or service manuals.

▲ connection or operation of the unit in any way that does not comply with the technical or safety regulations applicable in the country where the product is used.

▲ damages/defects caused by force majeure or any other condition that is beyond the control of BEHRINGER.

5. Any repair or opening of the unit carried out by unauthorized personnel (user included) will void the warranty.

6. If an inspection of the product by BEHRINGER shows that the defect in question is not covered by the warranty, the inspection costs are payable by the customer.

7. Products which do not meet the terms of this warranty will be repaired exclusively at the buyer's expense. BEHRINGER will inform the buyer of any such circumstance. If the buyer fails to submit a written repair order within 6 weeks after notification, BEHRINGER will return the unit C.O.D. with a separate invoice for freight and packing. Such costs will also be invoiced separately when the buyer has sent in a written repair order.

§ 5 WARRANTY TRANSFERABILITY

This warranty is extended exclusively to the original buyer (customer of retail dealer) and is not transferable to anyone who may subsequently purchase this product. No other person (retail dealer, etc.) shall be entitled to give any warranty promise on behalf of BEHRINGER.

§ 6 CLAIM FOR DAMAGES

Failure of BEHRINGER to provide proper warranty service shall not entitle the buyer to claim (consequential) damages. In no event shall the liability of BEHRINGER exceed the invoiced value of the product.

§ 7 OTHER WARRANTY RIGHTS AND NATIONAL LAW

1. This warranty does not exclude or limit the buyer's statutory rights provided by national law, in particular, any such rights against the seller that arise from a legally effective purchase contract.

2. The warranty regulations mentioned herein are applicable unless they constitute an infringement of national warranty law.

* Customers in the European Union please contact BEHRINGER Germany Support for further details.

Technical specifications and appearance subject to change without notice. The information contained herein is correct at the time of printing. The names of companies, institutions or publications pictured or mentioned and their respective logos are registered trademarks of their respective owners. Their use neither constitutes a claim of the trademarks by BEHRINGER® nor affiliation of the trademark owners with BEHRINGER®. BEHRINGER® accepts no liability for any loss which may be suffered by any person who relies either wholly or in part upon any description, photograph or statement contained herein. Colors and specifications depicted may vary slightly from product. No part of this book may be reproduced or transmitted in any form or by any means, electronic or mechanical, including photocopying and recording of any kind, for any purpose, without the express written permission of BEHRINGER Spezielle Studiotechnik GmbH. BEHRINGER® is a registered trademark.

ALL RIGHTS RESERVED. © 2004 BEHRINGER Spezielle Studiotechnik GmbH.
BEHRINGER Spezielle Studiotechnik GmbH, Hanns-Martin-Schleyer-Str. 36-38,
47877 Willich-Müncheide II, Germany
Tel. +49 2154 9206 0, Fax +49 2154 9206 4903